

SMSC USB97C100

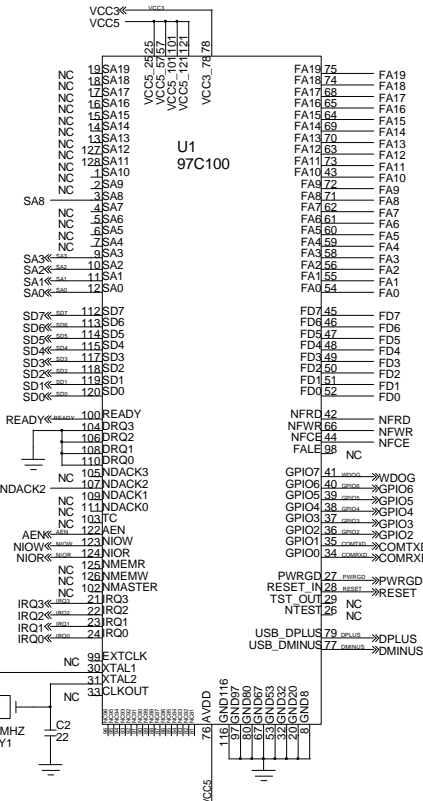

Flash ROM 128Kx8

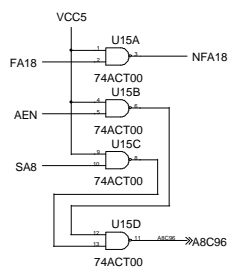
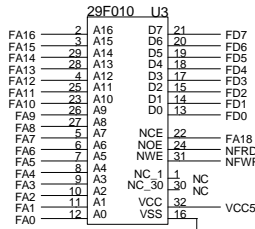

ROMulator ZIF Socket / Header

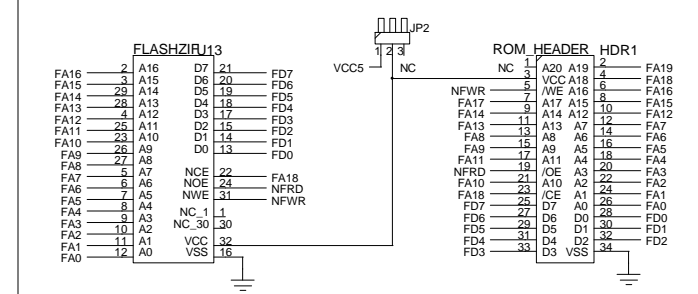

(For Debug / Test Use Only)

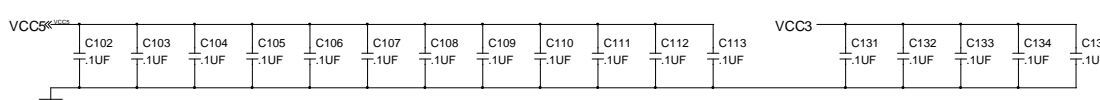

Standard Microsystems Corporation			
USB97C100 USB Ethernet Evaluation Board			
(Minimal Implementation)			
Doc No:	EV97C100-10BT	Rev:	C
Monday, June 14, 1999			
Page 1 of 3			

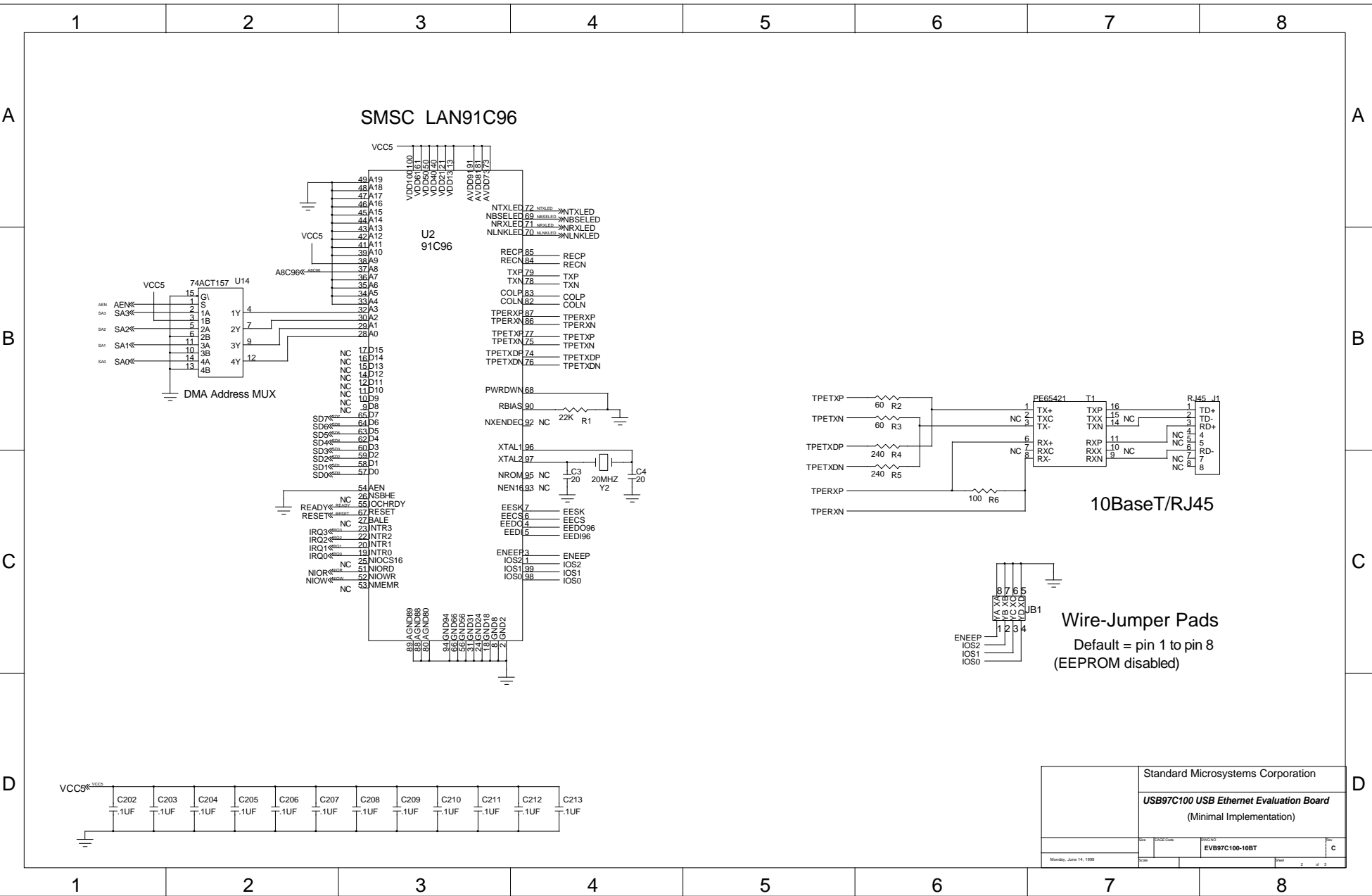

Standard Microsystems Corporation	
USB97C100 USB Ethernet Evaluation Board (Minimal Implementation)	
Doc Code	970301
Doc	EVB97C100-10BT
Rev	C
Monday, June 14, 1999	
Page	2 of 3

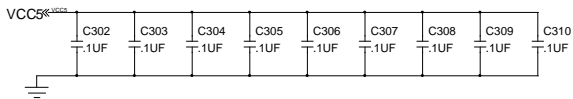
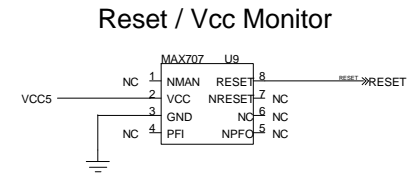
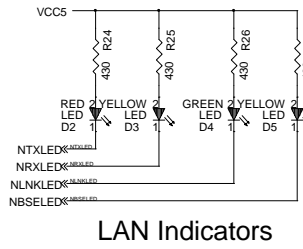
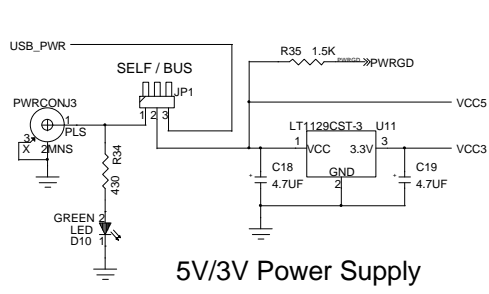
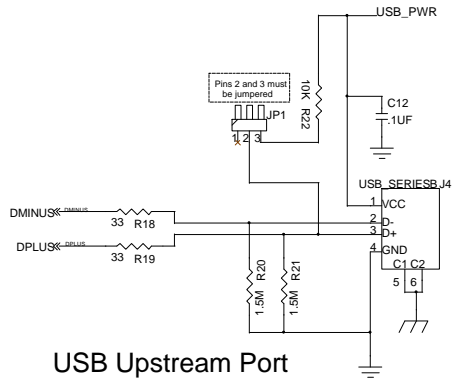

Standard Microsystems Corporation	
USB97C100 USB Ethernet Evaluation Board (Minimal Implementation)	
Doc. Code	970011
Part	EV97C100-10BT
Monday, June 14, 1999	Page 3 of 3